

G 2800 OC

<i>English</i>	2
<i>Español</i>	14
<i>Français</i>	27

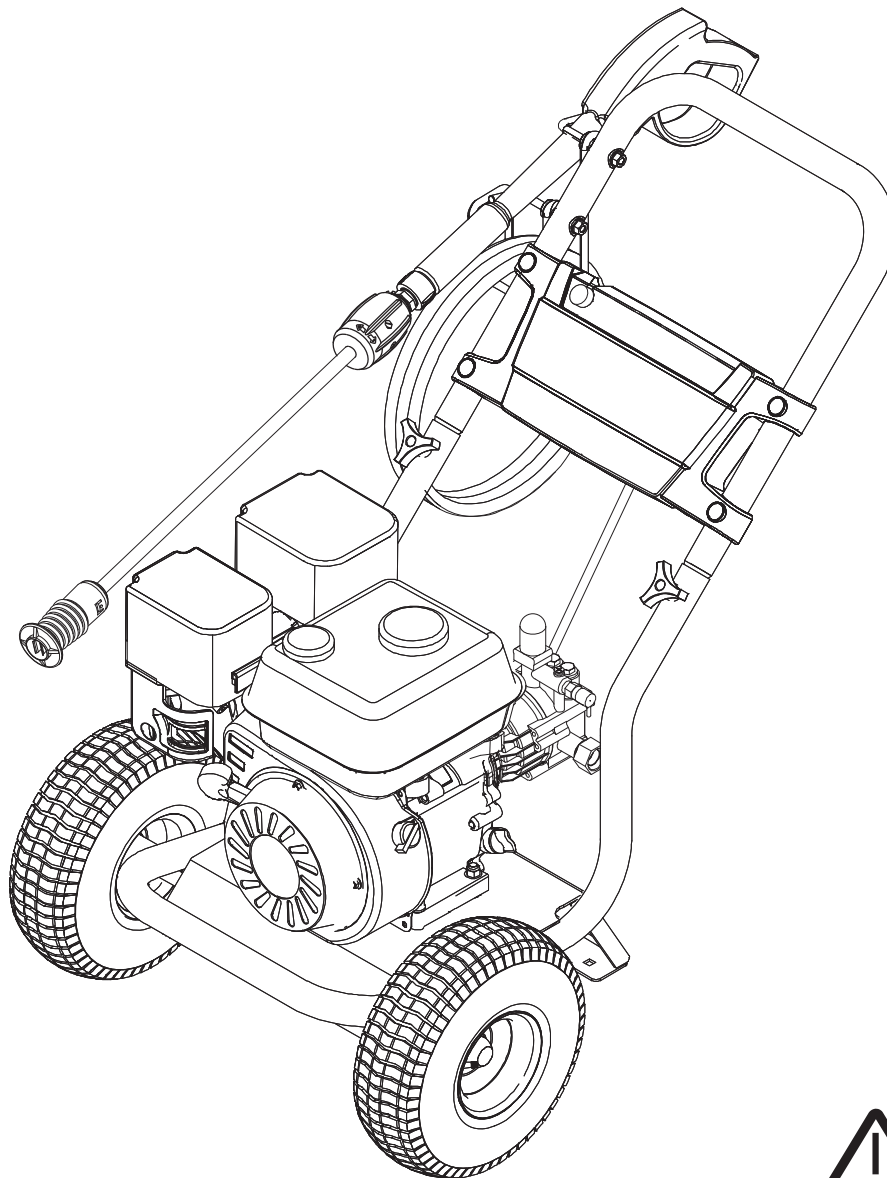

HIGH PRESSURE WASHER OPERATOR MANUAL

Model Overview	3
Important Safety Instructions	4
Assembly Instructions	5
Operating Instructions	7
Using the Accessories	8
Working With Detergents	9
Taking a Break	9
Shutting Down & Clean-Up	10
Winterizing and Long-Term Storage	10
Maintenance Instructions	10
Cleaning Tips	11
Troubleshooting	12

Specifications

G 2800 OC	
Operating Pressure	2800 PSI
Water Volume	2.3 GPM
Detergent Suction	0.15 - 0.20 GPM
Engine	KXS® 196
Part No.	1.107-258.0
Serial No.	

Safety Alert Symbols

DANGER

Indicates “an imminently hazardous situation which, if not avoided, will result in death or serious injury.”

WARNING

Indicates “a potentially hazardous situation which, if not avoided, could result in death or injury.”

CAUTION

Indicates “a potentially hazardous situation which, if not avoided, may result in minor or moderate injury or in property damage incidents.”

Owner/User Responsibility

The owner and/or user must have an understanding of the manufacturer’s operating instructions and warnings before using this pressure washer. Warning information should be emphasized and understood. If the operator is not fluent in English, the manufacturer’s instructions and warnings shall be read to and discussed with the operator in the operator’s native language by the purchaser/owner, making sure that the operator comprehends its contents. Owner and/or user must study and maintain for future reference the manufacturer’s instructions.

Kärcher Customer Support USA/ Canada

Call: **1-800-537-4129** for help or visit our website:

karcher.com/us

Please take a moment to register your pressure washer online at:

www.karcher-register.com

Kärcher Customer Support México

Call: **01-800-024-13-13** for help or visit our

website: www.karcher.com.mx

MODEL OVERVIEW

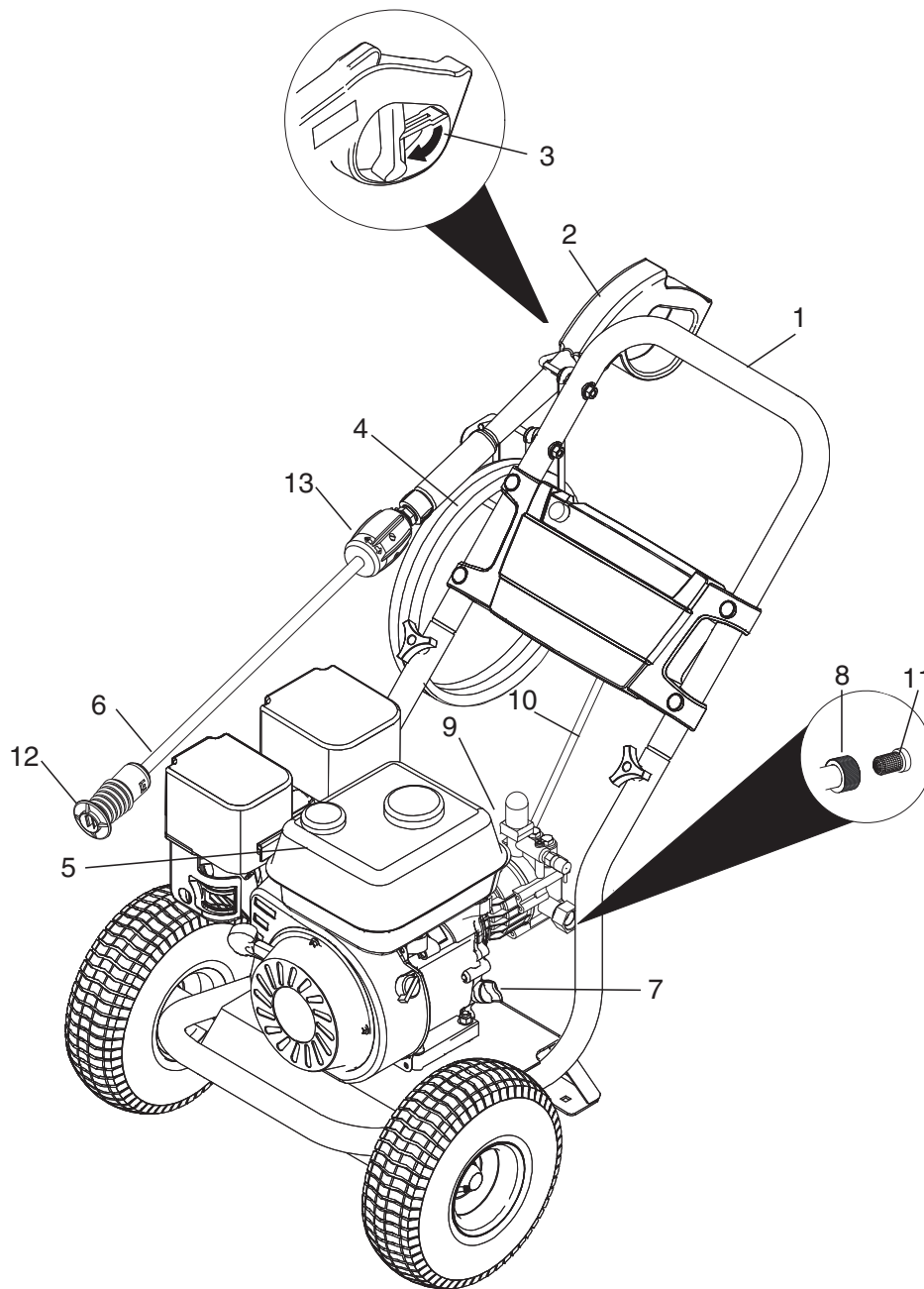

- | | | | |
|---|-------------------------|----|--|
| 1 | Handle | 8 | Water inlet with garden hose connector |
| 2 | Trigger gun | 9 | High pressure outlet |
| 3 | Trigger gun safety lock | 10 | Detergent suction tube with filter |
| 4 | High pressure hose | 11 | Water inlet filter |
| 5 | Gas tank | 12 | Vario Nozzle |
| 6 | Spray wand | 13 | Remote Control |
| 7 | Dipstick | | |
- For engine details see engine manual.

IMPORTANT SAFETY INSTRUCTIONS

- Read the operating instructions of the engine manufacturer before start-up and follow the safety instructions carefully.

WARNING

When using this product, basic precautions should always be followed, including the following:

- Read all instructions before using product.
- To reduce the risk of injury, close supervision is necessary when the product is used near children.
- Know how to stop the product and bleed pressures quickly. Be thoroughly familiar with the controls.
- Stay alert – watch what you are doing.
- Do not operate when fatigued or under the influence of alcohol or drugs.
- Keep operating area clear of all persons.
- Do not overreach or stand on unstable support. Keep good footing and balance at all times.
- Wear safety goggles and ear protection.
- Follow the maintenance instructions specified in the manual.
- To avoid risks, all repairs and replacement of spare parts should only be carried out by trained personnel.
- Tire pressure should not exceed max. 25 psi.

WARNING

Risk of injection or injury – Do not direct Discharge stream At persons.

- High pressure jets can be dangerous if misused. The jet must not be directed at persons, animals, electrical devices, or the unit itself.

DANGER

Do not spray electrical connections, electrical outlets or fixtures.

WARNING

Risk of explosion –Do not spray flammable liquids. Operate only where open flame or torch is permitted.

- Do not use acids, solvents, or any alkaline or flammable material in this product. These products can cause physical injuries to the operator and irreversible damage to the machine.

WARNING

Gun kicks back – Hold with both hands.

- The trigger gun safety lock prevents the trigger from accidentally being engaged. This safety feature must be engaged when replacing nozzles or not in use.

WARNING

The engine exhaust from this product contains chemicals known to the State of California to cause cancer, birth defects or other reproductive harm. Operation of this equipment may create sparks that can start fires around dry vegetation. A spark arrestor may be required. Operator should contact local fire agencies for laws or regulations.

CAUTION

Risk of asphyxiation – Use this product only in a well ventilated area.

- Operate and fuel machine in a well ventilated area, free of devices featuring an open pilot or flame such as boilers, water heaters, etc.

CAUTION

Risk of fire – Do not add fuel when the product is operating or still hot.

CAUTION

Risk of fire - Do not put container with flammable products into the nozzle holder.

- Do not operate if fuel has been spilled. Instead, move machine to different location and avoid creating sparks.
- This machine has hot surfaces which can cause burns. Operate in a safe environment and away from children.
- Do not touch hot surfaces or allow accessories to contact hot surfaces.
- Do not leave machine running unattended.
- Avoid tipping machine on its side.

SAVE THESE INSTRUCTIONS

WATER SUPPLY (Cold Water Only)



⚠ CAUTION

When connecting to water supply mains, local regulations of your municipal water company must be observed. In some areas connecting directly to public drinking water supply may require a backflow prevention device. This is to ensure that there is no feedback of chemicals into the water supply. Use a water filter to avoid potential damage from dirt in the water supply.

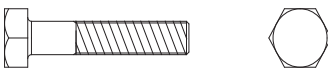
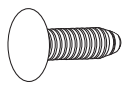
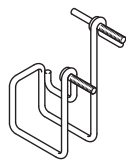
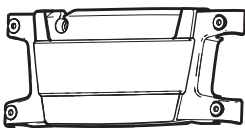

- Garden hose must be at least 5/8 inch diameter.
- Flow rate of water supply must not fall below 2.5 GPM (gallons per minute)
- Flow rate can be determined by running the water for one minute into an empty 5-gallon container.
- The water supply temperature must not exceed 122°F/50°C.
- Never use the pressure washer to draw in water contaminated with solvents, e.g. paint thinners, gasoline, oil, etc.
- Always prevent debris from being drawn into the unit by using a clean water source. Use additional water filter.
- Do not operate pressure washer without the water turned on.

ASSEMBLY INSTRUCTIONS

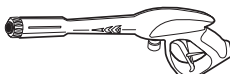
Hardware (included)

	Description	Purpose	Illustration	Qty
A	Knob	Joint Assembly		2
B	1/4" Bolt	Joint Assembly		2
C	Nylon Rivet	Gun Holder Assembly		4
D	Gun/Hose Storage	Gun Holder Assembly		1
E	Nozzle Holder	Detergent Holder		1
F	High Pressure Hose	Spray Gun Assembly		1
G	Spray Gun	Spray Gun Assembly		1

Hardware (included)

	Description	Purpose	Illustration	Qty
H	Wand	Wand Assembly		1
I	Nut	Gun/Hose Storage Assembly		2
J	Washer	Gun/Hose Storage Assembly		2

Assembling

→ STEP 1:

Attach the handle to the frame of the pressure washer. Align holes, insert bolts (B), and tighten with knobs (A).

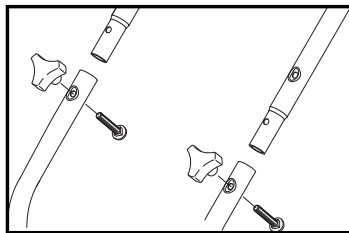

→ STEP 2:

Mount the gun/hose storage (D) to the handle and tighten with nuts (J) and washer (K).

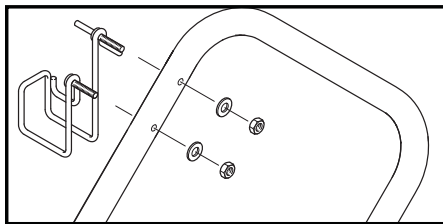

→ STEP 3:

Mount the detergent hose holder (E) with enclosed nylon rivets (C) to pressure washer

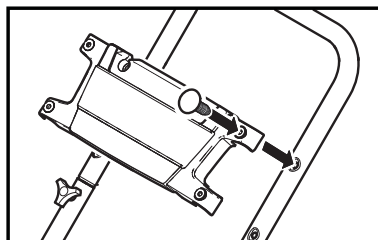

→ STEP 4:

Attach the wand (I) to the spray gun (G). Push the wand (I) into the trigger gun (G) and then thread the connection.

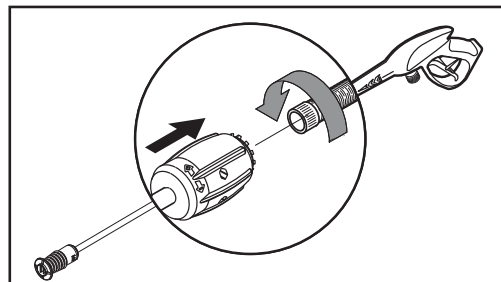

OPERATING INSTRUCTIONS

→ STEP 1:

Pull back the spring loaded collar at the spray gun and insert the high pressure hose.

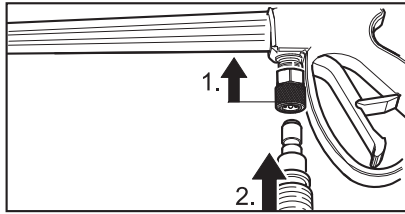

Release the collar and push the high pressure hose until the collar clicks.

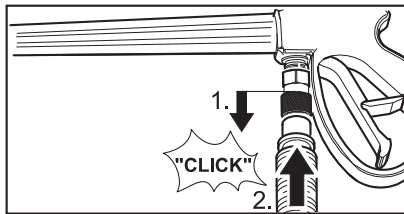

⚠ CAUTION

Engine shipped without oil. Before starting engine, fill with oil. Do not over-fill. Do not run the engine with a high or low oil level as this can cause engine damage.

→ If you have further questions regarding the engine, please refer to the engine manual included with the unit.

→ STEP 2:

Check oil level. Insert and remove dipstick without screwing it into the filler neck. Check the oil level shown on the dipstick.

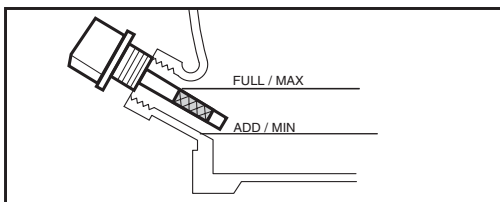

Be sure the machine is level when checking the oil level. (Refer to the engines operating manual for seasonal grades).

We recommend that the oil be changed after the first 5 hours of use, then once every 50 hours.

→ STEP 3:

Fill gas tank with unleaded gasoline.

Do not use leaded gasoline.

Do not add oil to the gasoline.

→ STEP 4:

Pull back the spring loaded collar at the high

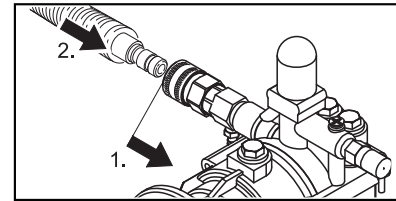

pressure outlet and insert the high pressure hose.

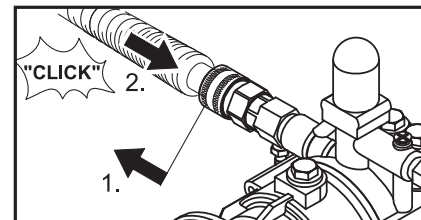

Release the collar and push the high pressure hose until the collar clicks.

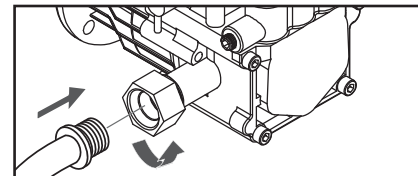

→ STEP 5:

Connect garden hose to unit's water inlet.

→ STEP 6:

Connect garden hose to the cold water source and turn water completely on.

Do not use hot water.

→ STEP 7:

Unlock the trigger gun safety lock. Trigger the gun to eliminate trapped air, wait for a steady flow of water to emerge from the spray nozzle.

→ STEP 8:

Open fuel valve. Pull the choke rod to the ON position (on a warm engine, leave the choke rod in the OFF position).

→ STEP 9:

Move the engine stop switch to the ON position.

OPERATING INSTRUCTIONS

→ STEP 10:

Pull the starter handle. If the engine fails to start after 3 pulls, squeeze the trigger gun to release pressure, and repeat step.

After the engine warms up enough to run smoothly move choke rod to OFF position.

For engine details see engine manual.

USING THE ACCESSORIES

→ WARNING

To avoid serious injury, never point spray nozzle at yourself, other persons or animals.

Always test an inconspicuous area before cleaning with high pressure.

VARIO NOZZLE

The vario nozzle allows you to adjust the cleaning pressure.

- To clean at maximum pressure, the wand must be positioned to the high pressure setting (Max).

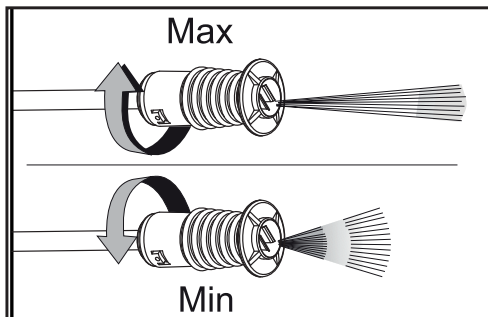

- For lower pressure turn the wand collar in the minus (Min) direction.

To apply detergent, the wand must be positioned to the lower pressure setting (Mix).

WORKING WITH DETERGENTS

Detergents can only be applied with vario nozzle on the low position.

→ **STEP 1:**

Move nozzle to the low position.

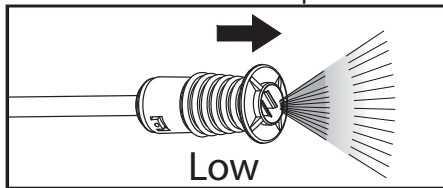

→ **STEP 2:**

Set remote pressure control knob to the high flow position "+"

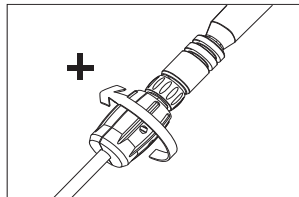

→ **STEP 3:**

Fill a container with Kärcher detergent. Place the filter end of detergent suction tube into the container.

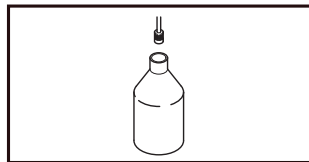

→ **STEP 4:**

With the engine running, pull trigger to operate unit.

Liquid detergent is drawn into the unit and mixed with water.

Apply detergent to work area.

Do not allow detergent to dry on surface.

→ **STEP 5:**

Always draw fresh water through the detergent suction tube when the cleaning job is done, to rinse/flush any remaining detergents from the injection system.

For best results see Cleaning Tips for specific information on how to clean different surfaces.

Detergents

⚠ CAUTION

This unit has been designed for use with cleaning detergents recommended by the manufacturer.

The use of other cleaning detergent may affect the operation of the machine and void the warranty.

Always Use Kärcher Detergent for Best Results

Kärcher biodegradable detergents are specially formulated to protect the environment and your pressure washer. The special formula won't clog the suction tube filter and will protect the internal parts of the pressure washer for a longer life. For Kärcher Detergents, check your retailer or visit our website:

karcher.com/us

⚠ CAUTION

Never use:

- Bleach, chlorine products or other corrosive chemicals
- Liquids containing solvents (i.e., paint thinners, gasoline, oils.)
- Tri-sodium phosphate products
- Ammonia products
- Acid-based products

These chemicals will harm the unit and will damage the surface being cleaned.

Use of these items will void the warranty.

TAKING A BREAK ...five minutes or more

→ **STEP 1:**

Move the engine stop switch to the OFF position. For engine details see engine manual.

→ **STEP 2:**

Release trigger and engage safety lock.

SHUTTING DOWN & CLEAN-UP

→ STEP 1:

If detergents have been used, remove detergent suction tube from container and insert into 1 gallon of fresh water.

Siphon water at low pressure for one minute to clear the line of residual detergent.

→ STEP 2:

Move the engine stop switch to the OFF position. Close the fuel valve.

→ STEP 3:

Turn off the water source.

→ STEP 4:

Press trigger to release water pressure.

→ STEP 5:

Release trigger and engage gun safety lock.

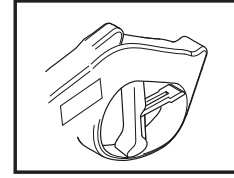

STEP 6:

→ Disconnect the garden hose from the water inlet on the unit.

STEP 7:

→ Disconnect the high pressure hose from the high pressure outlet. Store the high pressure hose in the gun holder assembly.

WINTERIZING AND LONG-TERM STORAGE

It is highly recommended to use Kärcher's Pump Guard (part number 9.558-998.0) before winter storage and during the cleaning season to protect the pump from freezing and premature wear.

→ STEP 1:

Turn engine switch to the OFF position

→ STEP 2:

Disconnect all hoses.

→ STEP 3:

Unscrew cap from Pump Guard bottle.

→ STEP 4:

Remove internal seal.

→ STEP 5:

Reattach cap to Pump Guard bottle and remove black protective cap.

→ STEP 6:

Screw bottle into water inlet on pressure washer pump and squeeze.

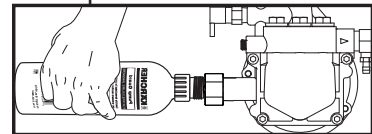

→ STEP 7:

With ignition OFF, pull starter rope until fluid starts to exit.

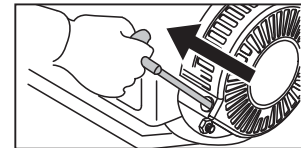

→ STEP 8:

Unscrew bottle. Store or dispose properly.

⚠ CAUTION

Failure to follow the above directions may result in damage to the pump assembly and accessories and void the warranty.

MAINTENANCE INSTRUCTIONS

Kärcher pump

Initial Use

All Kärcher pumps ship with oil already inside direct from the factory. There is no need to add oil.

Pump Inspection

You should routinely make a visual inspection of the pressure washer's pump. If you notice oil leaking around the pump seals, you should take the pressure washer to a Kärcher-Authorized Service Center for repair. (You can locate a service center in your area online at: www.karcher-service.com).

Pump Maintenance

The pump on your Kärcher pressure washer does not require maintenance. Any attempts to service or alter the pump may damage your pressure washer and void your product warranty.

Engine

Carry out maintenance tasks for the engine according to the specifications provided in the operating instructions provided by engine manufacturer.

CLEANING TIPS

Deck Cleaning

(with or without detergent). Pre-rinse deck and surrounding area with fresh water. If using Kärcher Deck Wash, apply to surface at low pressure. For best results, limit your work area to smaller sections of approximately 25 square feet. Allow Deck Wash to remain on surface 1-3 minutes. Do not allow detergent to dry on surface. Rinse at high pressure in a long sweeping motion keeping the spray nozzle approximately 3-6 inches from the cleaning surface. Always clean from top to bottom and from left to right. When moving on to a new section of the cleaning surface, be sure to overlap the previous section to eliminate stop marks and ensure a more even cleaning result.

Cars, Boats & Motorcycles

(with or without detergent). Pre-rinse vehicle with fresh water. If using Kärcher Touchless Vehicle Wash, apply to surface at low pressure. For best results, clean one side of vehicle at a time and always apply detergent from bottom to top, do not allow detergent to dry on surface. If needed, use special wash brush attachment (not included) to remove stubborn dirt. Rinse at high pressure in a sweeping motion keeping the spray nozzle approximately 6-8 inches from the cleaning surface (distance should increase when rinsing pin-striping or other sensitive surfaces). Always clean from top to bottom and from left to right. For best results, wipe surface dry with a chamois or soft dry cloth.

House Siding

(with or without detergent). Pre-rinse cleaning surface with fresh water. If using Kärcher Pressure Wash, apply to surface at low pressure (for best results, limit your work area to sections of approximately 6 feet and always apply detergent from bottom to top). Allow detergent to remain on surface 1-3 minutes. Do not allow detergent to dry on surface, if surface appears to be drying, simply wet down surface with fresh water. If needed, use special wash brush attachment (not included) to remove stubborn dirt. Rinse at high pressure from top to bottom in an even sweeping motion keeping the spray nozzle approximately 6 inches from the cleaning surface.

Cement Patios, Brick and Stone

(with or without detergent). Pre-rinse cleaning surface with fresh water. If using Kärcher Pressure Wash or Degreaser, apply to surface at low pressure. For best results, limit your work area to smaller sections of approximately 25 square feet. Allow Pressure Wash or Degreaser to remain on surface 1-3 minutes. Do not allow detergent to dry on surface. Rinse at high pressure in a sweeping motion keeping the spray nozzle approximately 3-6 inches from the cleaning surface. Always clean from top to bottom and from left to right. For removing extremely stubborn stains, use a DirtBlaster® Spray Nozzle (sold separately).

Barbecue Grills, Outdoor Power Equipment & Gardening Tools

(with or without detergent). Pre-rinse cleaning surface with fresh water. If using Kärcher Pressure Wash or Degreaser, apply detergent at low pressure. Allow Pressure Wash to remain on surface 1-3 minutes. Do not allow detergent to dry on surface. Rinse at high pressure keeping the spray nozzle approximately 3-6 inches from the cleaning surface. For removing extremely stubborn dirt, it may be necessary to move the spray nozzle even closer to the surface for greater dirt cutting action.

Recommendations

- Before cleaning any surface an inconspicuous area should be cleaned to test spray pattern and distance for maximum cleaning results.
- If painted surfaces are peeling or chipping, use extreme caution as pressure washer may remove the loose paint from the surface.
- When using on surfaces which might come in contact with food, flush surfaces with plenty of drinking water.
- For additional cleaning tips, visit our website at karcher.com/us

CLEANING TIPS

Patio & Lawn Furniture

(with or without detergent). Pre-rinse furniture and surrounding area with fresh water. If using Pressure Wash, apply to surface at low pressure. Allow Pressure Wash to remain on surface 1-3 minutes. Do not allow detergent to dry on surface. If needed use special Wash Brush Attachment (not included) to remove stubborn dirt. Rinse at high pressure in a sweeping motion keeping the spray nozzle approximately 3-6 inches from the cleaning surface. For best results, clean from top to bottom and from left to right.

Optional Accessories

Optional accessories are available to further enhance your cleaning capabilities. These accessories are accurate as of the printing date of this manual. Please check our website:

karcher.com/us for pricing and up-to-date information.

- Extension Hose
- DirtBlaster® Spray Nozzle
- Universal Wash Brush Kit

TROUBLESHOOTING

CAUTION

Remove the spark plug cable to prevent accidental ignition of the engine before making any repair.

Symptom	Cause	Solution
ENGINE WILL NOT START	No gasoline	Fill gas tank
	Choke is not in the correct position	Slide choke lever out to closed position
	Water pressure built up in the machine	Squeeze the trigger to release the pressure
	For additional engine problems refer to the engine manual.	
UNIT DOES NOT REACH HIGH PRESSURE	Diameter of garden hose is too small	Replace with a 5/8 inch or larger garden hose
	Water supply is restricted	Check garden hose for kinks, leaks and blockage
	Not enough inlet water supply	Turn water on full force. Check garden hose for kinks, leaks or blockage
	Water inlet filter is clogged	Remove filter and rinse out in warm water
	Black detergent nozzle is attached	Remove black detergent nozzle and attach high pressure nozzle
OUTPUT PRESSURE VARIES HIGH AND LOW	Not enough inlet water supply.	Turn water on full force. Check garden hose for kinks, leaks or blockage
	Pump is sucking air	Check that hoses and fittings are air tight. Turn off machine and purge pump by squeezing trigger gun until a steady flow of water emerges through the nozzle
	Water inlet filter is clogged	Remove filter and rinse out in warm water
	Spray nozzle is obstructed	Blow out or remove debris with a fine needle
	Calcified gun, hose or spray wand	Run distilled vinegar through detergent suction tube

TROUBLESHOOTING

Symptom	Cause	Solution
NO DETERGENT	Detergent suction tube not properly connected to the machine	Check connection
	Detergent is too thick	Dilute detergent, for best results use Kärcher detergent
	Filter on detergent suction tube is clogged	Run warm water through filter to remove debris
	Damaged or clogged detergent suction tube	Remove obstruction or replace detergent suction tube
	A high pressure nozzle is attached	Replace with black detergent nozzle
	Spray nozzle is obstructed	Blow out or remove debris with fine needle
GARDEN HOSE CONNECTION LEAKS	Loose fittings	Tighten fittings
	Missing/worn rubber washer	Insert new washer
SPRAY WAND LEAKS	Spray wand not properly attached	Turn the swivel nut of the gun clockwise until connection is tight
	Broken o-ring or plastic insert	Visit www.karcher-help.com or locate a service center at www.karcher-service.com
PUMP IS NOISY	Not enough gas or engine oil	Check that hoses and fittings are air tight. Turn off machine and purge pump by squeezing trigger gun until a steady flow of water emerges through the nozzle
WATER LEAKS FROM PUMP (UP TO 10 DROP PER MINUTE IS PERMISSIBLE)	Loose fittings	Check fittings
	Water seals are damaged or worn.	Visit www.karcher-help.com or locate a service center at www.karcher-service.com
	Thermal protection device is activated.	Thermal protection device will auto reset. Do not run pump for more than 5 minutes without spraying
OIL DRIP	Oil seals are damaged or worn	Visit www.karcher-help.com or locate a service center at www.karcher-service.com

If the symptom you are experiencing is not listed above, or if the provided solutions do not solve your issue, please visit our extensive online troubleshooting database at:

www.karcher-help.com

High Pressure Washers

Limited 12 month warranty

Cold water gasoline pressure washers



This Kärcher product is warranted by Kärcher to be free of defects in workmanship and materials under normal use.

Specific warranty applies to:

- Pumps and engines are warranted for one (1) years on parts and labor.
- Frames, handles and detergent tanks, as well as other structural components, carry a one (1) year parts and labor warranty.
- Standard accessories and attachments are warranted for a ninety (90) day period.
- Any commercial, industrial or rental use of this equipment will reduce the warranty to ninety (90) days.

The warranty period is calculated from the date of purchase by the end user and covers cost for replacement parts / equipment and warranty labor performed. In order to verify a warranty situation, the machine must be evaluated by an Authorized Kärcher Service Center. A copy of the original purchase receipt or gift receipt from the original retailer must also accompany the warranty claim. To locate the nearest authorized Kärcher service center, please visit our website at www.karcher-service.com.

Kärcher's obligation under this warranty shall strictly be limited, at Kärcher's option, either to replace or repair, through Kärcher direct or through an Authorized Kärcher Service Dealer without charge during the warranty period any part, which in the opinion of the manufacturer, shows defect in workmanship or material. Service will be scheduled according to the normal work flow and business hours at the service center, and availability of replacement parts. All decisions of Kärcher with regard to this limited warranty shall be final.

This warranty does not cover:

- Merchandise sold as reconditioned, used, demonstration or floor models.
- Merchandise purchased on eBay and other online auction web sites.
- Damage caused by misuse, neglect, accident, abuse, improper handling, freezing, normal wear and tear or non-compliance with operator's manual.
- Damage caused by water sediment, contaminated water supply or use of chemicals and detergents not approved by or recommended by Kärcher.
- Damage caused by acts of nature such as floods, fires, earthquakes, lightning strikes, etc.
- Devices or accessories not distributed or approved by Kärcher. Any use of such said devices or accessories will void implied warranty.
- Repairs made by the end user or any service center not authorized by Kärcher. Any such tampering with Kärcher equipment or accessories will void the implied warranty.
- Any cost for shipping by the customer or authorized service center of the alleged defective part or equipment.

This warranty applies only to parts and equipment manufactured by Kärcher. Equipment provided, but not manufactured by Kärcher (such as gasoline engines) are subject to warranties and service through said manufacturers' service centers according to the terms and conditions provided by the respective original equipment manufacturer. Kärcher is not authorized and has no responsibility to provide warranty service for such equipment.

This warranty is **non-transferable** and applies only to products purchased through a Kärcher authorized reseller in the United States and Canada. This warranty gives you specific legal rights. You may have other rights, which vary by country and state/province.

Please register online at www.karcher-register.com. Online registration is quick, free and provides you with a confirmation email for your records.

If you do not have internet access, please return the warranty registration card included in the accessory bag. It is not necessary to use an envelope. Please remember to use a first-class postage stamp. The Postal service will not deliver without a stamp.